



INSTRUCTION MANUAL

RODENT 714

FREEDOM BREEDER



RODENT 714

INSTRUCTION MANUAL

RODENT 714
FREEDOM BREEDER



Product Description

This rack is made of 304 Stainless Steel, no rust ever!

The Rodent 0714 rack works perfect for breeding and/or holding Hamsters and other similar sized rodents.

The FB25 tray fits the Rodent 0714 rack. The FB25 tray confides to USDA regulations for keeping Hamsters. This tray works just as well for other similar sized rodents and is perfectly fine for breeding rats or African soft furred rats as well. FB25 comes in semi-clear only.

Caution

Channels and backstops have sharp edges, take precautions.

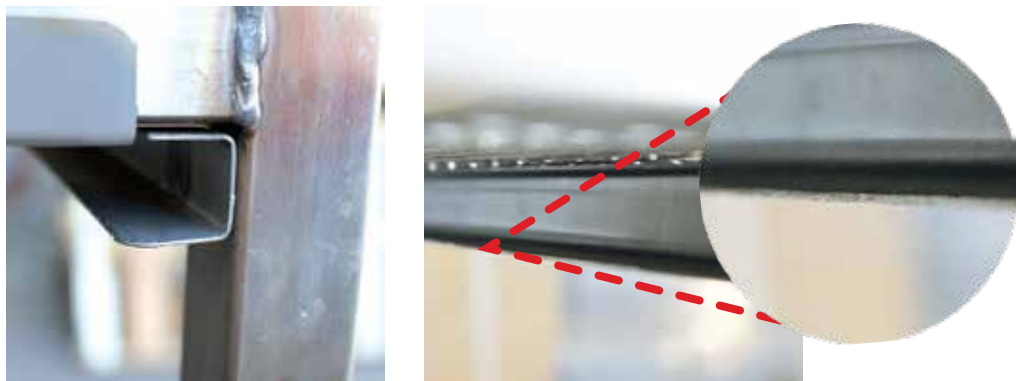

*Any comments or suggestions on this Instructions Manual please send us an email to manuel@freedombreeder.com

INSTRUCTION MANUAL

RODENT 714 FREEDOM BREEDER



Packing List

PART #	DESCRIPTION	QTY
1	Rodent 714 Stainless Steel Levels	7
2	FB25 Tubs	14
3	Water System	1
4	Base Frame	1
5	4" Heavy Duty Casters (Nuts and Bolts Included)	4

***Any extra items purchased can be found on your invoice.
*Packing list may vary depending on your order.**

Requirements



1/2" Socket



Ratchet



Cutter



Gloves



Two persons
***Recommended**

INSTRUCTION MANUAL

RODENT 714 FREEDOM BREEDER



Assembly

STEP 1. Unwrapping

The Rodent 714 is packed in a cardboard carton and plastic wrap for protection during shipment. Carefully unpack the items and remove the pallet.

Notice that the Rodent 714 is almost assembled.

Note: If you detect any issue or damage at the moment of the delivery please contact us before you accept the shipment.



STEP 2. Parts



Count all parts to make sure nothing is missing.

See Packing list for Descriptions and Quantities.

PART #	DESCRIPTION	QTY
1	Rodent 714 Stainless Steel Levels	7
2	FB25 Tubs	14
3	Water System	1
4	Base Frame	1
5	4" Heavy Duty Casters (Screws and Bolts Included)	4

Continue to step 3

INSTRUCTION MANUAL

RODENT 714
FREEDOM BREEDER



Assembly

STEP 3. Casters

Notice that the rack may or may not had the casters installed.

In case they have been installed, you just need to turn upside down the frame with the casters to the correct position.

In case the casters are not installed:

- 1.- Find the casters, nuts, and bolts.
- 2.- Insert the bolts into the holes in the lower frame.
- 3.- Using the ratchet and the 1/2" socket, tighten the caster with the bolts on each corner of the frame until the bolts are flush to the tubing of the frame.

Note: Make sure to put all the nuts and bolts included (3 per caster) and not overtighten the nuts.

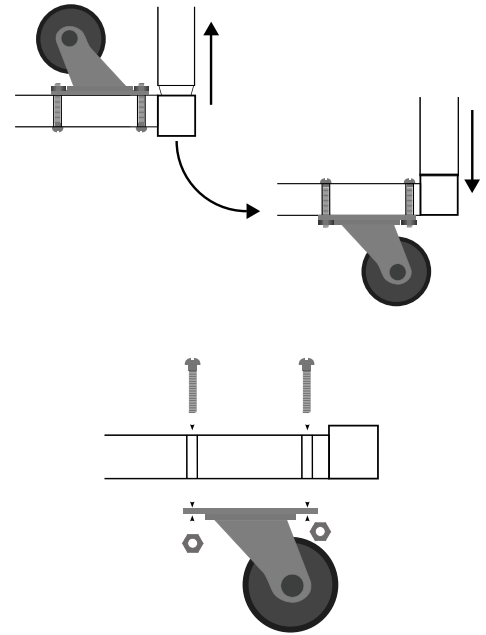

STEP 4. Stacking the levels

Stacked the levels over the base frame with the casters installed. You don't have to use tools on this step.



Assembly

STEP 5. Trays

Insert the trays thru the channels on each level.



STEP 6. Water system



Find the extra tube included to connect the water lines already installed.

Depending on your choice, you can use a Pressure regulator or a Gravity system.

For the **Gravity system**, put the bucket on top of your rack and let the gravity distribute the water into the water lines.

In the case of using a **Pressure regulator**, connect the water lines into the main pipe previously connected to the pressure regulator.

Continue to step 7

INSTRUCTION MANUAL

RODENT 714
FREEDOM BREEDER



Assembly

STEP 7. Water system cover (If bought)

Place the leg covers to the frames taking care of leaving enough space for the water tube.



STEP 8. Water system test

1. Please run water through your new racking systems for a day before placing rodents or bedding in the rack.
2. Check for any disconnected tubing.
3. Adjust valves by hand to stop any leak and test again for another day. (Do not tighten with tools!)

This test is to avoid flooding your rodents.



Visit our Website, Facebook page and Instagram



www.freedombreeder.com



[@freedombreeder](https://www.facebook.com/freedombreeder)



[/freedombreeder](https://www.instagram.com/freedombreeder)

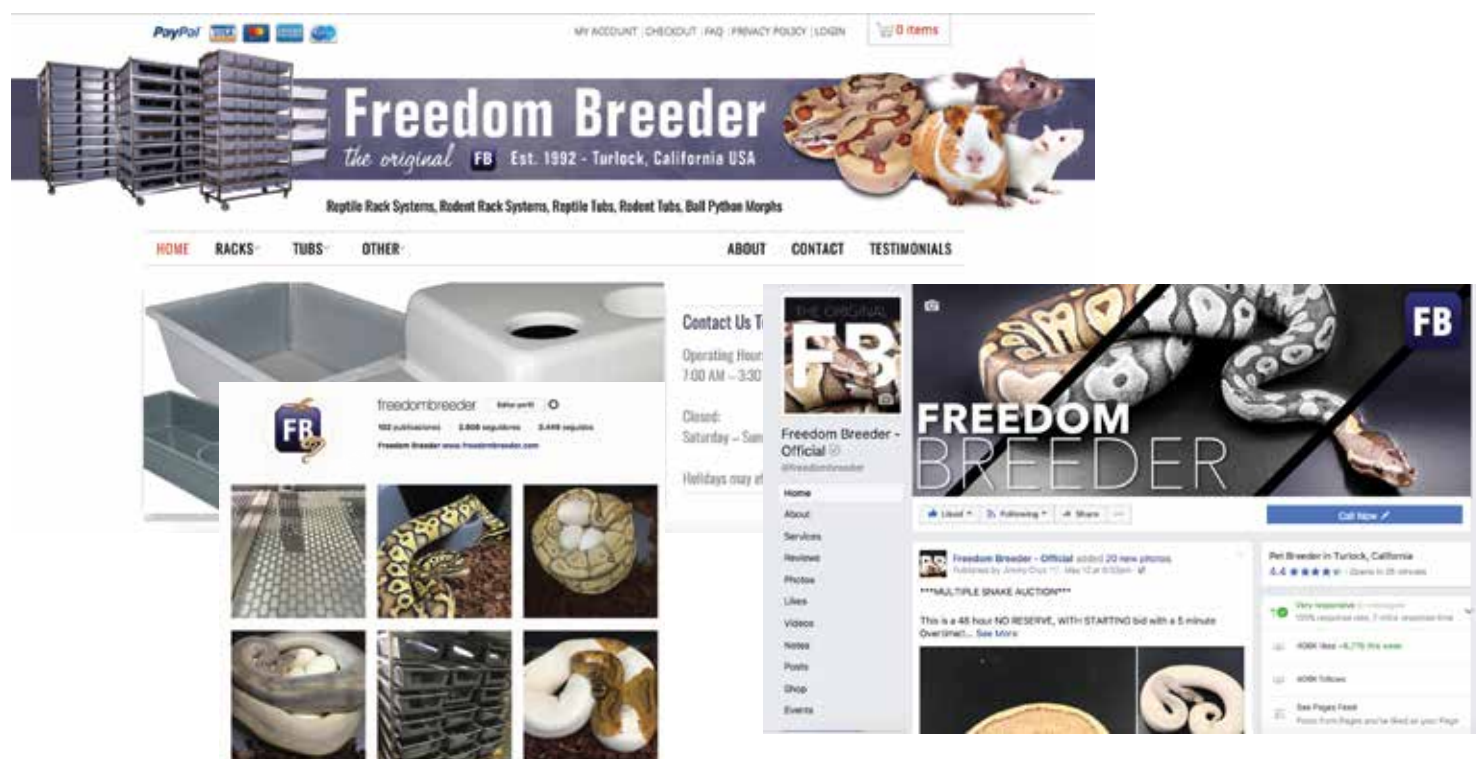

ATTENTION CUSTOMERS:

Please inform the appropriate personnel to always INSPECT YOUR SHIPMENT for damage PRIOR to signing the delivery receipt. If there is obvious damage, do not accept the shipment without NOTING IN DETAIL and taking pictures of the damage on ALL copies of the carrier's delivery receipt. Please have the freight driver SIGN ALL COPIES to acknowledge your damage notation.

-Thank You!

*Any comments or suggestions on this Instructions Manual please send us an email to manuel@freedombreeder.com

www.FreedomBreeder.com 209.664.9600 EXT. 201/202/203
Freedom Breeder · 2306 S. Daubenberger Rd. Turlock, CA 95380 USA